

AE 403 Indicator

Software rev: V 1.00 & above



Easy Reference:

Model name of the scale:	
Serial number of the unit:	
Software revision number (Displayed when power is first turned on):	
Date of Purchase:	
Name of the supplier and place:	

CONTENTS

P.N. 1.10.0.0.13103, Rev B3, December 2019

1.0	INTRODUCTION	1
2.0	SPECIFICATIONS	2
3.0	INSTALLATION	3
3.1	LOCATING THE INDICATOR	3
3.2	LIST OF ACCESSORIES	3
3.3	SETTING UP THE INDICATOR	4
3.4	CONNECTIONS	4
3.4.1	Connection of load cell to the connector	4
3.4.2	Connection of load cell to the board	5
3.4.3	Connection of RS-232 to the connector	5
3.4.4	Connection of RS-232 to the board	5
3.4.5	Connection of relay drivers	6
4.0	KEY DESCRIPTIONS	7
5.0	DISPLAYS	8
6.0	OPERATION	8
6.1	ZEROING THE DISPLAY	8
6.2	TARING	9
6.3	WEIGHING A SAMPLE	10
6.4	CHANGING THE WEIGHING UNITS	10
6.5	PRESET TARE	10
6.7	CHECK-WEIGHING	11
6.8	ACCUMULATED TOTAL	13
6.9	PERCENT WEIGHING	14
6.10	ANIMAL (Dynamic) WEIGHING	15
6.10.1	Animal weighing procedure	15
6.11	ANIMAL 2 (DYNAMIC 2) WEIGHING	16
6.11.1	Animal 2 weighing procedure	16
6.12	HOLD/ PEAK FUNCTION	17
7.0	USER PARAMETERS	18
7.1	SCALE PARAMETERS	18
7.2	RS-232 PARAMETERS	19
7.2.1	Print settings	20
7.2.2	PC settings	21
7.2.3	Command settings	21
8.0	BATTERY OPERATION	22
9.0	RS-232 INTERFACE	22
9.1	INPUT COMMANDS FORMAT	27
10.0	RELAY INTERFACE	27
11.0	CALIBRATION	28
12.0	ERROR CODES	29
13.0	REPLACEMENT PARTS AND ACCESSORIES	30
14.0	SERVICE INFORMATION	30
	WARRANTY STATEMENT	31

1.0 INTRODUCTION

- The AE 403 indicator provides the user with the electronics necessary to build an accurate, fast, versatile weighing system.
- Functions include, weighing, check weighing, parts counting, animal weighing and percent weighing.
- The system includes automatic zero tracking, audible alarm for check-weighing, semi-automatic tare and an accumulation facility that allows individual weights or counts to be stored and the total recalled.
- The scales have a bi-directional RS-232 interface for communicating with a PC or printer.
- RS-232 outputs include Real time Clock, English, German, French, Spanish, Italian or Portuguese language text and data required for GLP reports.
- The indicator can be used with 1- to 4 load cell platforms.
- Internal rechargeable battery and IP-67 rated enclosure allow for a fully portable and rigged weighing system.

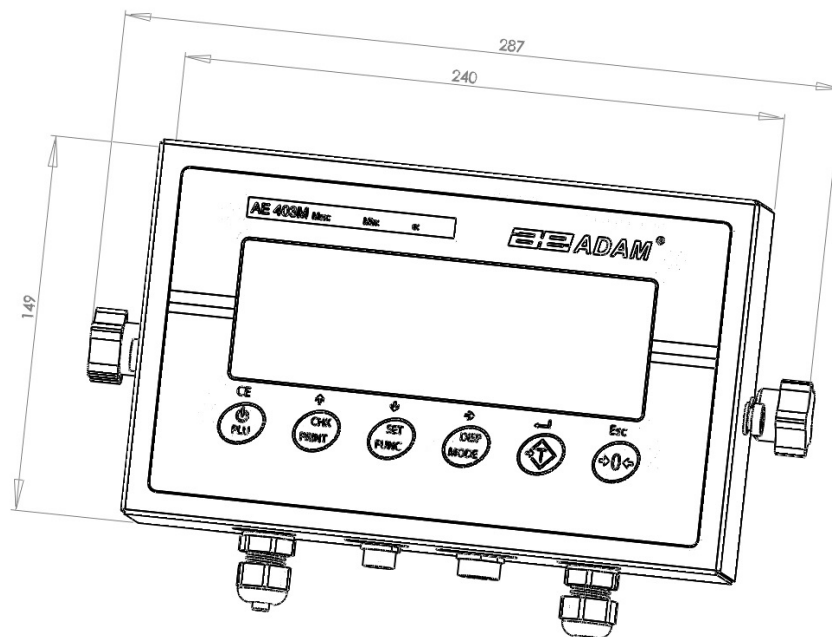



2.0 SPECIFICATIONS

External resolution ratio	1/1000-1/30000
Non-linear error	±0.016% F.S
Range of signal input of the transducer	0-20mV
Load cell drive capacity	up to 4, 350Ω or 1000Ω load cells
Load cell excitation	+ 5V DC
Load Cell Connection	6 wire connection (2 x excitation, 2 x sense, 2 x signal) plus shield.
Calibration	Automatic External
Stabilisation Time	2 seconds typical
Power supply	6V 4.5Ah Rechargeable battery And AC/DC 12V 800mA adapter power;
Power consumption	0.1VA
Overall dimension	287 x 240 x 149 mm (including bracket)
Balance Housing	Indicator: IP 67 rated Stainless Steel
Net weight	2.8 kg
Operating temperature	0C-40C
Operating humidity	≤85% RH
Applications	General Purpose Weighing Scales
Functions	Weighing, Check weighing, Parts counting, Memory Accumulation, Animal weighing, Percent weighing, Peak hold
Display	6 digits, 40mm digit height LCD digital display with backlight
Weighing units	Grams, Kilogram, pound, ounce, pound/ounce; Newton;
Symbol indication	battery; stable; net weight; zero set; Animal Weighing; Hold
Interface	RS-232 bi-directional Interface

3.0 INSTALLATION

3.1 LOCATING THE INDICATOR

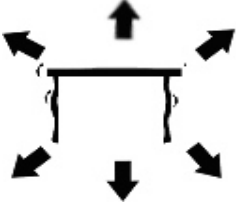
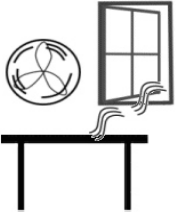
	<ul style="list-style-type: none">• The indicator should not be placed in a location that will reduce the accuracy.• Avoid extremes of temperature. Do not place in direct sunlight or near air conditioning vents.
	<ul style="list-style-type: none">• Avoid unsuitable tables or surfaces.• Avoid unstable power sources. Do not use near large users of electricity such as welding equipment or large motors.
	<ul style="list-style-type: none">• Do not place near vibrating machinery.• Avoid air movement such as from fans or opening doors. Do not place near open windows or air-conditioning vents.
	<ul style="list-style-type: none">• Keep the indicator clean. Do not stack material on the indicator when not in use.

3.2 LIST OF ACCESSORIES

Your packet contains-

- ✓ AC adapter
- ✓ Indicator
- ✓ Wall mount bracket and mounting hardware
- ✓ Instruction manual

3.3 SETTING UP THE INDICATOR

- Attach the power supply module to the connector underneath the indicator. Press the [On/Off] key. The software revision number will be displayed followed by a self-test showing all digits before the zero is displayed along with the unit of weight that was selected last.

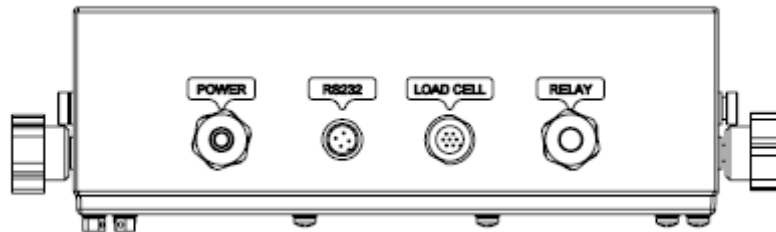

3.4 CONNECTIONS

Depending on what model you have purchased, the connection of the load cell could be different:

3.4.1 Connection of load cell to the connector

Please see figure 1

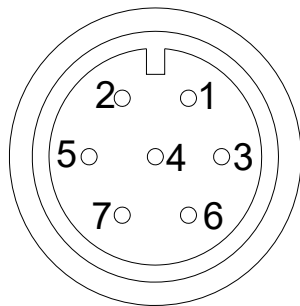

1: Pin +S,	+Sense
2: Pin +E	+Excitation
3: Pin Shield	Shield
4: Pin -E	-Excitation
5: Pin -S	-Sense
6: Pin +IN	+Signal
7: Pin -IN	-Signal

As viewed from the back of the indicator

Note:

For 4 wire load cell, connect the load cell +Excitation and +Sense together at the connector and -Excitation and -Sense together at the connector.

3.4.2 Connection of load cell to the board

Please see figure 2



		Board (terminal block)
1: Pin +S,	+Sense	E+
2: Pin +E	+Excitation	Avcc
3: Pin -E	-Excitation	Avss
4: Pin -S	-Sense	E-
5: Pin AGND	Shield	Sh
6: Pin +IN	+Signal	S+
7: Pin -IN	-Signal	S-

If there is no connector outside case you will have to connect the load cell directly to the board.

3.4.3 Connection of RS-232 to the connector

RS-232 serial interface is a plug as figure 3 shows:

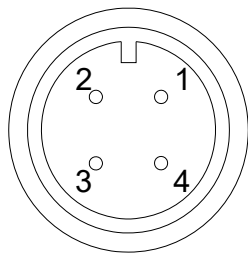

1: Pin GND,	Signal Ground
2: Pin RXD,	Received Data
3: Pin TXD,	Transmitted Data

As viewed from the back of the indicator

See section 9 for details of the RS-232 Interface.

3.4.4 Connection of RS-232 to the board

Please see figure 4

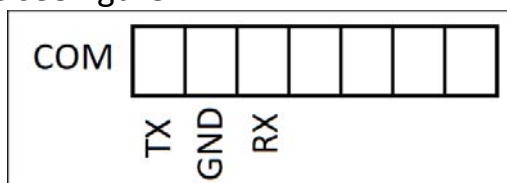

PIN TXD,	Transmitted Data
PIN GND,	Signal Ground
PIN RX,	Received Data

If there is no connector outside case you will have to connect the RS 232 directly to the board.

3.4.5 Connection of relay drivers

The output to drive external relays is on the circuit board inside the enclosure. To gain access you must remove the 6 screws securing the front to the rear of the case. Pass the wires for the relays through the grommet on the rear panel. The wires will connect to the PCB using the terminal strip P1.

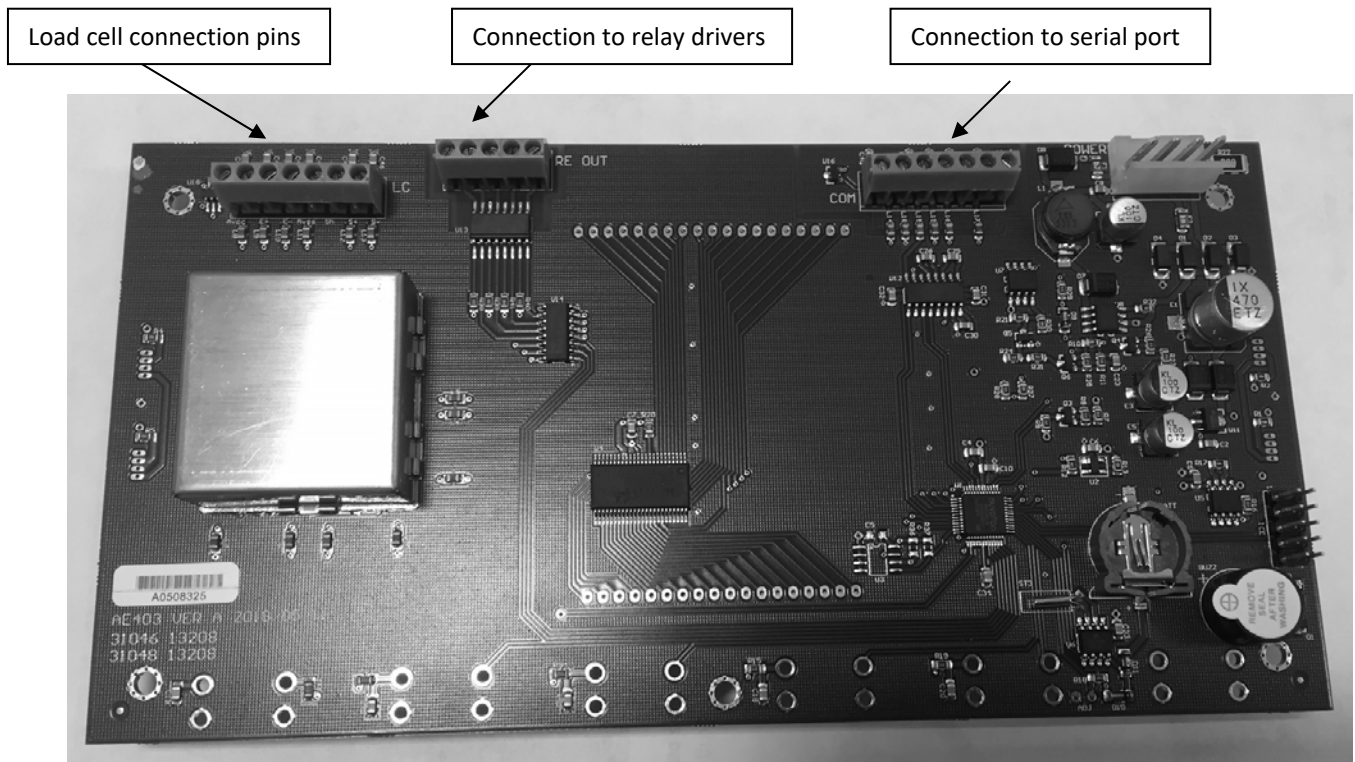
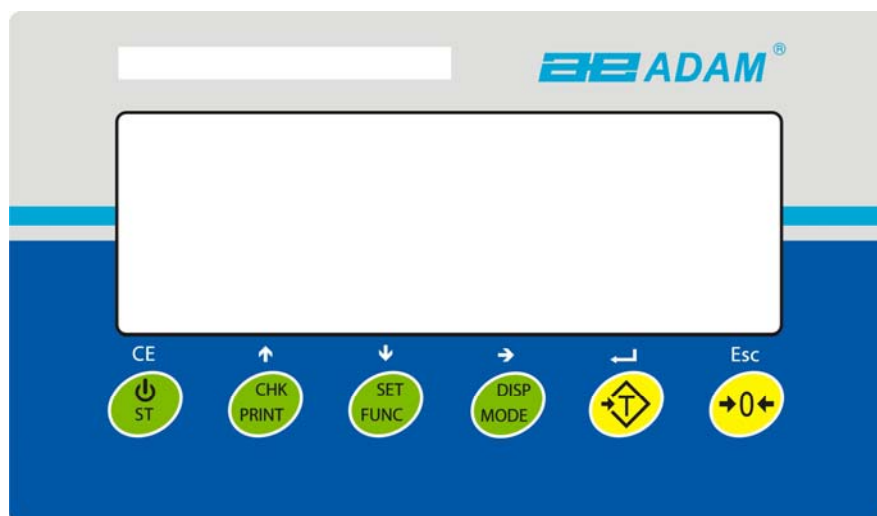





FIGURE 5 AE403 CIRCUIT BOARD

The circuit to control the relays requires an external voltage compatible with the relays used. For more information see section 10.

4.0 KEY DESCRIPTIONS



 [Tare/↵]	<p>Sets the zero point for all subsequent weighing. The display shows zero.</p> <p>Tares the scale. Stores the weight currently on the scale as tare value, subtracts the tare value from the gross weight and shows the results.</p> <p>A secondary function,  is of “Enter” key used when setting up the value for the Parameters.</p>
[CHK/PRINT/↑]	<p>CHK: Selects checkweighing. Used to set the Low/High weight limits while checkweighing.</p> <p>PRINT: Sends the results to a PC or a Printer using the RS-232 interface. It also adds the value to the accumulation memory if the accumulation function is not automatic.</p> <p>↑: Up directional button for scrolling. Also used for incrementing the active digit when setting a value for Parameters.</p>
[Disp/Mode/→]	<p>Selects the weighing unit to be displayed from those which are enabled. See parameter rs1 in section 7.2.</p> <p>A secondary function, → is to move the active/flashing digit to the right when setting values for Parameters.</p>
[Func/Set/↓]	<p>Selects the Functions of the scale. If the scale is weighing, it will select parts counting. If it is not in weighing mode, it will return the user to weighing.</p> <p>A secondary function (SET) will bring up the settings menu. Also used to set values used for parameters</p>
[→0←/Esc]	<p>Used to zero the scale.</p> <p>A secondary function (ESC) is to return to normal operation when the scale is in a Parameter setting mode.</p>
 / ST/ CE]	<p>To switch on and switch off the indicator.</p> <p>ST: Secondary function allows the user to store/ recall checkweighing limits.</p>

5.0 DISPLAYS

The LCD display will show a value and a unit to the right of the digits. In addition the LED's above the display will show when a weight is below or above checkweighing limits.

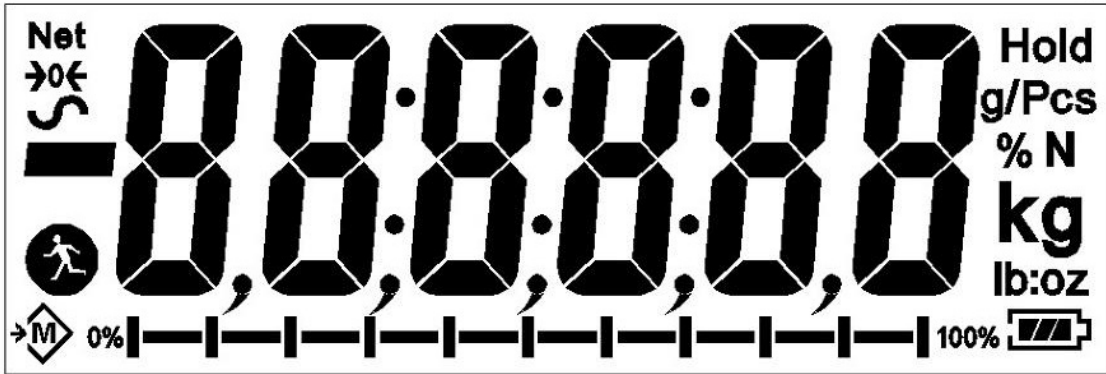

Other symbols will show when a weight has been tared (NET) the scale is at zero and stable, if a value has been stored in memory or when the animal weighing function has been enabled. A battery symbols will show the state of charge of the internal battery.

6.0 OPERATION

6.1 ZEROING THE DISPLAY

- You can press the [**→0←/Esc**] key at any time to set the zero point. This will usually be necessary when the platform is empty. You can only zero off a weight up to a maximum of 20% of the scale capacity. When the zero point is obtained the display will show an indicator for zero.

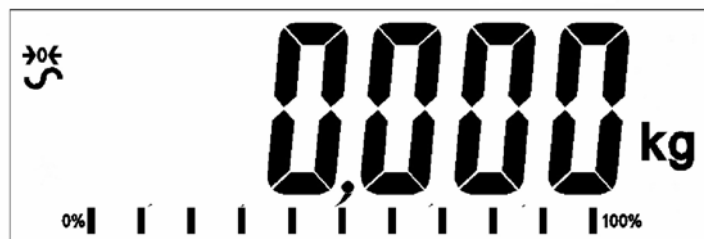

- The indicator has an automatic re-zeroing function to account for minor drifting or accumulation of material on the platform. However you may need to press the [**→0←/Esc**] key to re-zero the indicator if small amounts of weight are shown when the platform is empty.

6.2 TARING

- Zero the indicator by pressing the [**→0←/Esc**] key if necessary. The “ZERO” indicator will be ON. **→0←**

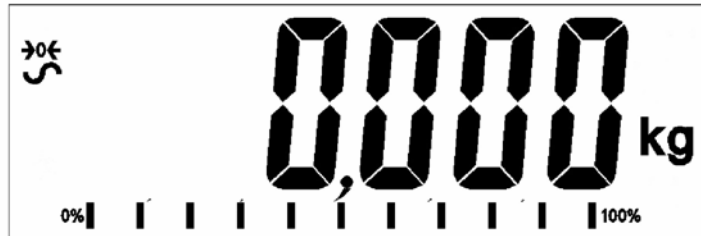

- Place a container onto a connected weighing scale platform, a value for its weight will be displayed.
- Press the [**Tare/⇐**] key to tare the scale. The weight that was displayed is stored as the tare value and that value is subtracted from the display, leaving zero on the display. The “NET indicator will be ON. As a product is added only the net weight of the product will be shown. The scale could be tared a second time if another type of product was to be added to the first one. Again only the weight that is added after taring will be displayed.

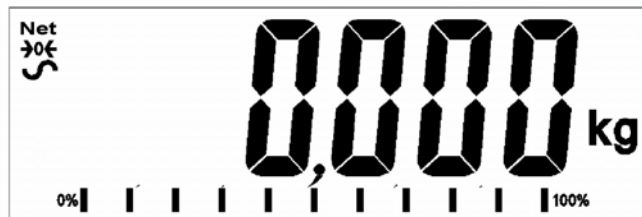

- When the container is removed a negative value will be shown. If the scale was tared just before removing the container this value is the gross weight of the container plus all products that was removed. The “ZERO” indicator will be on to indicate that the platform is back to the same condition as it was when zero was last set.
- To delete a Tare value, press [**→0←/Esc**] when the pan is empty.

6.3 WEIGHING A SAMPLE

To determine the weight of a sample, first tare the empty container if it is to be used and then place the sample in the container. The display will show the net weight of the sample and the units of weight currently in use.

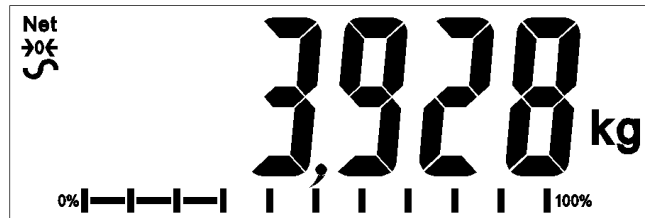

6.4 CHANGING THE WEIGHING UNITS

To change the weighing units, press the **[Unit/Mode]** key. Press the key again to move to the next unit type in the queue.

6.5 PRESET TARE

To preset a tare weight value, press and hold the **[Tare/↵]** key. The display will now show a flashing unit which can be increased or decreased using the ↑ or ↓ directional keys and the → directional key to move to the next digit.

Once you have set the desired sample size, press the **[Tare/↵]** key.

6.6 PARTS COUNTING

If parts counting is enabled, it is possible to count parts using a sample of the parts to determine average piece weight.

- Before starting, tare the weight of any container that may be used, leaving the empty container on the scale. Place a known number of samples in the container, if used. The number should match the options for parts counting, i.e., 10, 20, 50, 100 or 200 pieces.
- Press the **[Func/Set]** key to select the weighing mode.
- Using the directional buttons ↑ or ↓, scroll through to the parts counting mode, "**Count**" will be shown on the display. Press **[Tare/↵]** to confirm.
- Once in parts counting mode the "Pcs" indicator will appear on the right-hand side of the display. Place the sample onto the scale and press the **[Disp/Mode]** key.

- The display will now show a flashing unit which can be increased or decreased using the ↑ or ↓ directional keys. Once you have set the desired sample size, press the **[Tare/↵]** key.
- From here you will return to the main piece counting display which will show the number of pieces assigned to the weight on the scale. Adding or removing weight will cause the number of pieces to change in relation to the weight per piece.



- Press the **[Func/Set]** key to change the mode.

6.7 CHECK-WEIGHING

Check-weighing is a procedure to cause lamps to come on (and if enabled, an alarm to sound) when the weight on the scale meets or exceeds values stored in memory. The memory holds the last values for a high and a low limit when the power is turned off. The user can set either one limit or both as described below.

The limits can be set when the scale is in weighing or parts counting modes. After limits have been set the Check-weighing function is enabled.

When a weight is placed on the scale the LED's above the display will show if the weight is above or below the limits and the beeper will sound, if the beeper is enabled.

- Press the **[Func/Set]** key to select the weighing mode.
- Using the directional buttons ↑ or ↓, scroll through to the normal weighing mode, “**Weight**” will be shown on the display. Press **[Tare/↵]** to confirm.
- Once in normal weighing mode, hold the **[CHK/PRINT]** button for 2-3 seconds. “**Hi**” will appear on the display followed by a value on the display with a flashing digit.
- To set the high limit, use the directional keys ↑ or ↓ to scroll between numbers 1-9 and the → directional key to move to the next digit. Press **[Tare/↵]** to confirm.
- Once confirmed, “**Lo**” will appear on the display followed by a value on the display with a flashing digit.
- To set the low limit, follow the same process as before using the directional keys to scroll and **[Tare/↵]** to confirm.

- Once confirmed you will return to the normal weighing screen. Placing an object onto the scale will now turn the indicator display red, yellow or green depending on whether the value is within, under or over the set weight limits.

For checkweighing in parts counting mode, use the directional buttons ↑ or ↓, scroll through to the parts counting mode, “**Count**” will be shown on the display. Press [**Tare/↵**] to confirm and follow the same process as outlined above.

Relay outputs and checkweighing

The relay outputs are open collector drivers to control an external relay. The relays will be active when the corresponding LED is on during check-weighing. The ZERO relay output will be on when the scale is showing the display is at Zero.

BOTH LIMITS SET	The display backlight will be green when the weight is between the limits	CHK bP = In / out / off The beeper will sound when the weight is between the limits, i.e. OK F3 bEP = bP OtL Beeper will sound if weight is outside the limits.
LOW LIMIT SET HIGH LIMIT is set to zero	The display will be amber when the weight is less than the Low Limit. Above the Low Limit the display backlight will be green,	CHK bP = In The beeper will be off when the weight is less than the Low Limit. Above the Low Limit the beeper will be on CHK bP = Out The beeper will be on sound when the weight is below the Low Limit
HIGH LIMIT SET LOW LIMIT is set to zero	The display will show a red backlight until High limit is reached, then green backlight above the High limit. Beeper will turn on after High limit.	CHK bP = In The beeper will be on when the weight is less than the High Limit. Above the High Limit the beeper will be off. CHK bP = Out When set to bP OtL the indicator alarm will turn on below the high limit with red backlight. The beeper will be off when the weight is below the High Limit, on when it is above the High limit.
BOTH LIMITS SET. LOW IS SET GREATER THAN HIGH	This condition is not allowed.	

NOTE:

Weight must be more than 20 scale divisions for check weighing to operate. Below 20 scale divisions the LED's will not light and the beeper will not be on.

The Check-weighing function can be set up during Weighing or Parts Counting by entering values as Low or/and High Limits keyed in by the user. The limits are displayed in **kg (or Lb)** or **pcs** respectively.



Checkweighing during Parts Counting

To disable the Check-Weighing function enter zero into both limits by pressing the **[Func/Set]** key when the current limits values are displayed during the setting procedure, then pressing **[Tare/↵]** to store the zero values.

The values set for the check-weighing will remain in memory when the weighing units or the function changes to parts counting but will not be active. The will become active again when the weighing unit or parts counting that was active at the time the limits were set is reactivated.

6.8 ACCUMULATED TOTAL

- The scale can be set to accumulate manually by pressing the **[CHK/ Print]** key or automatically when a weight is removed from the scale. The accumulation function is available when weighing or when counting parts. However the memory is cleared if the weighing units or functions are changed.
- When the weight (or count) displayed is stored in memory the display will show "ACC 1" and then the total in memory for 2 seconds before returning to weighing. The RS-232 interface will output to a printer or PC.
- Remove the weight, allowing the scale to return to zero and put a second weight on. When this value is stored, the display will show "ACC 2", then the new total and finally the value of the second weight. Repeat as necessary to add all the values needed to the memory.
- To view the total in memory press the **[CHK/Print]** key when there is no weight on the scale. The display will show the number of entries and the total.
- To clear the memory (set the value to zero) press the **[Power/ST]** key during the time the totals are being displayed, "Clear" will flash on the display for 2-3 seconds and then return to the usual weighing display.

6.9 PERCENT WEIGHING

The scale can be set to perform percent weighing.

The scale will use a mass on the platform as the 100% reference weight.

- Press the **[Func/Set]** key to select the weighing mode.
- Using the directional buttons \uparrow or \downarrow , scroll through to the parts counting mode, “**Percent**” will be shown on the display. Press **[Tare/←]** to confirm.
- Once in percent weighing mode the “%” indicator will appear on the right-hand side of the display.

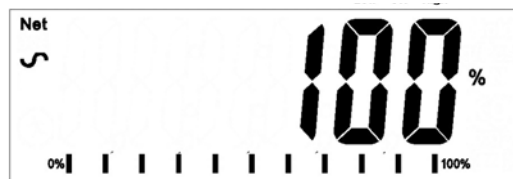

- Remove the sample weight. Then any other weight placed on the scale will be displayed as a percentage of the original sample. For example, if 3500g is placed on the scale and percent weighing is selected, the display will show 100.0%. Remove the 3500g weight and place a 3000g weight. The display will show 85.7% as 3000g is 85.7% of 3500g.



- The number of decimal points will depend on the weight used in comparison to the capacity of the system. A smaller weight will show only “100%” while a larger weight might show “100.00%”.
- If the scale was showing zero weight when entering this function, then the user must manually enter the weight to be set as 100% as described below.
- Make reference weight of 100% on platform.
- Press the **[Disp/Mode]** key. Display will show 100%.
- The weight entered must be greater than 50 scale divisions.
- Press the **[Func/Set]** key to select a new weighing mode.

NOTE:

The display may jump by large numbers unexpectedly if small weights are used to set as 100% reference. The scale checks if the weight is too small and will show Error 7.

6.10 ANIMAL (DYNAMIC) WEIGHING

The scale can be set to animal (dynamic) weighing for weighing any items that are unstable or may move.

The scale will use a special filter to minimise the effects of any movement while the moving animal or unstable samples are on the scale.

- Press **[Func/Set]** and scroll through the list of functions using the ↑ and ↓ directional keys
- Press **[Tare/↵]** to enter animal weighing. The display will show “LOAD” and the Animal/Dynamic weighing symbol . The scale is now ready to weigh an unstable animal or sample on a weighing scale platform.
- To use the Animal Weighing function it is necessary to set the amount of filtering required for the item to be weighed. More active animals will require a higher level of filtering to give a stable result. Press the **[Disp/Mode]**. The display will show “Fit x” where x is a value from 1 to 5. The higher the value the greater the amount of filter will be. To increment the value shown press the **[↑]** key then press the **[Tare/↵]** key to accept it.

6.10.1 Animal weighing procedure

- With the weighing scale platform empty the indicator display will show “LOAD”. Place containers or blankets onto the platform and press the **[→0←/Esc]** key to remove the weight of the containers or blankets, alternatively, a long press on the **[Tare/↵]** key, will retain the container or blanket value as “NET”.
- Place the animal or sample to be weighed on the platform.
- Press **[Tare/↵]** key to start to the measurement. The display will show the live measurements until a stable weight is determined. The time it takes for the stable value will depend upon the setting of the filter parameter in the first step.
- When a stable reading is found, the display will show this value, and the display will be locked until the **[→0←/Esc]** key is pressed. The display will show the “Hold” symbol while the display is locked.



- To weigh a second subject press the **[→0←/Esc]** key and the display will show “**LOAD**” and the function will be ready for a new measurement, if necessary to zero the display, press the **[→0←/Esc]** key again, and then place the next animal on the scale. The scale will detect the new weight and hold it as before.
- The scale will remain in the animal weighing mode until a new mode is selected using the **[Func/ Set]** key and **[Tare/←]** key to enter.

6.11 ANIMAL 2 (DYNAMIC 2) WEIGHING

The scale can be set to animal 2 (dynamic) weighing for sequential weighing of several items that are unstable.

This function allows the user to load several moving items into the platform at once, the scale will take a measurement of all items included. The function will then ask the user to remove one of the items, and then it will automatically measure and printout the weight of the removed item. The function it will repeat this process until there are no items left, or the user stops the function.

- Press **[Func/Set]** and scroll through the list of functions using the ↑ and ↓ directional keys
- Press **[Tare/←]** to enter animal 2 weighing. The display will show “**LOAD**” and the Animal/Dynamic weighing symbol . The scale is now ready to weigh an unstable animal or sample on a weighing scale platform.
- To use the Animal Weighing function it is necessary to set the amount of filtering required for the item to be weighed. More active animals will require a higher level of filtering to give a stable result. Press the **[Disp/Mode]**. The display will show “Flt x” where x is a value from 0 to 5. The higher the value the greater the amount of filter will be. To increment the value shown press the [↑] key then press the **[Tare/←]** key to accept it.

6.11.1 Animal 2 weighing procedure

- With the weighing scale platform empty the indicator display will show “**LOAD**”. Place containers or blankets onto the platform and press the **[→0←/Esc]** key to remove the weight of the containers or blankets, alternatively, a long press on the **[Tare/←]** key, will retain the container or blanket value as “**NET**”.
- Place the animals or sample to be weighed on the platform.
- Press **[Tare/←]** key to start to the measurement. The display will show the live measurements until a stable weight is determined. The time it takes for the stable value will depend upon the setting of the filter parameter in the first step.

- When a stable reading is found, the display will show this value, and the display will be locked for 2 seconds. The display will show the “**Hold**” symbol while the display is locked.



- After the 2 seconds delay, the display will now show “**UNLOAD**”, Remove one of the Animal or items, and press [**Tare/↵**] key to calculate the weight of the removed animal or item. The display will show the live measurements again, until a stable weight is determined.
- When a stable reading is found, the display will show this value, and the display will be locked for 2 seconds. The display will show the “**Hold**” symbol while the display is locked.
- After the 2 seconds delay, the scale will automatically print out the result. If all the animals or items have been removed, the scale will restart the function and it will show “**LOAD**”, otherwise the scale will continue to run the function and the display will show “**UNLOAD**”, and the function will continue to repeat the measurements and print outs until all the animals or items have been removed. The user can stop/restart the function at any time by pressing the [**→0←/Esc**] key.
- The scale will remain in the animal weighing mode until a new mode is selected using the [**Func/ Set**] key and [**Tare/↵**] key to enter.

6.12 HOLD/ PEAK FUNCTION

- Press [**Func/Set**] and scroll through the list of functions using the ↑ and ↓ directional keys
- Press [**Tare/↵**] to enter ‘**Hold**’ or ‘**Peak**’ mode. Hold will allow the user to weigh an object and hold the value, whilst the Peak function will allow you to complete multiple weighings and record the peak value.
- Place the object to be weighed onto the weighing platform, “**hold**” will appear in the top-right corner of the display.
- Once the weight has stabilised, the weight value will remain on the display until either more weight is added onto the weighing pan or the weighing mode is changed.
- If using the “**Peak**” mode, the recorded “**Peak**” can be held for set interval, and after that the “**Peak**” will be deleted automatically if a higher “**Peak**” hasn’t been recorded, the “**Peak**” release time can be set by pressing the [**Unit/ Mode**] key and using the directional keys ↑ and ↓ to set the “**Peak**” delete time interval in seconds, or to turn this off [del 2s – del 10s, or OFF].
- If the “**Peak**” release is set to OFF, the [**→0←/Esc**] key can be used to clear the “**Peak**”, and restart the function.

7.0 USER PARAMETERS

Pressing the **[Func/Set]** key and holding for 2 seconds during normal operation allows the user to access the parameters for customising the scale. The parameters are split into 2 groups:

1. Scale parameters (pressing the **[Func/Set]** key will access this automatically).
2. RS-232 parameters (can be accessed by selecting the 'rs 1' and 'rs 2' menu options in the scale parameters menu).

7.1 SCALE PARAMETERS

- Pressing the **[Func/C]** key and holding for 2 seconds during normal operation allows the user to access the parameters.
- Scroll through the list of functions using the ↑ and ↓ directional keys. Press **[Tare/←]** to enter a parameter.
- Press **[→0←/Esc]** to exit the scale parameter section and return to normal weighing.

This group of parameters is used to control the operation of the scale.

Parameter	Description	Options	Default setting
Time	Set Time.	Enter the time manually.	00:00:00
Date	Set date format and settings. Format for date can be changed when the display shows mmddyy, ddmmyy or yymmdd by pressing the [Pcs/□] key, then enter the date.	Enter the date format and then the numeric value manually.	mm:dd:yy
bL	Backlight set to always on, always off or automatic on whenever a weight is placed or a key is pressed	oFF on AUTO	AUTO
Power	Disable or set time increment to turn off scale	0 1 2 5 10 15 Off	2
Key bp	Key beeper settings	On Off	On
Chk bp	Checkweighing beeper settings	In Out Off	In
Unit	Enable or disable weighing	Kg	Kg

	units, will not allow to disable all units, at least one has to be enabled. Parts counting can be enabled/disabled	Grams lb oz lb:oz N (Newtons) PCS	
Auto-Z	Auto zero settings	0.5 1 1.5 2 2.5 3	0.5
Filter	Filter setting to slow, normal or fast	Slower Slowest Faster Fastest Then: 1-6	Faster
Rs 1	Brings up the 1 st RS232 menu. Includes PC, command and print settings	PC Cmd Print	
Rs 2	Brings up RS232 menu 2	PC Cmd	
S-id	Set Scale ID	To be entered manually	000000
U-id	Set User ID	To be entered manually	000000
rechar	Indicates time to recharge	-	-

7.2 RS-232 PARAMETERS

This group of parameters can be set by the user for setting the RS-232 active or not, baud rate, printing mode, accumulation mode, RS-232 language, and user or scale ID numbers.

- Pressing the **[Func/Set]** key and holding for 2 seconds during normal operation allows the user to access the parameters.
- Scroll through the list of functions using the ↑ and ↓ directional keys. Press **[Tare/↵]** to enter the 'rs 1' or 'rs 2' parameters when appearing on the display.
- 'Rs 1' will provide access to 'Print', 'PC' and 'Cmd' settings. 'Rs 2' includes 'PC' and 'Cmd' only. Press **[Tare/↵]** to confirm.
- When entering a mode, the user will be required to go through each step of the process by entering the desired values or selecting from the options listed in the table below and pressing the **[Tare/↵]** key to confirm.
- Press **[→0←/Esc]** to exit the scale parameter section and return to normal weighing.

7.2.1 Print settings

Parameter	Description	Options	Default Values or setting
[baud rate]	Baud Rate	1200 2400 4800 9600 19200 38400 57600 115200	9600
[Language]	Select Language	EnGLis (English) FrEnCH (French) GErmAn (German) SPAn (Spanish) Portug (Portuguese) Itail (Italian)	EnGLis
[Accumulation]	Enable or disable the Accumulation	on off	off
[Printing mode]	Printing Mode- Manual or Automatic	mAn, AUto P	mAn
[Printer/device]	Select the printer or device to print to	ATP LP50	ATP
[Number of copies]	Select the number of copies	Copy 1 Copy 2 Copy 3 Copy 4 Copy 5 Copy 6 Copy 7 Copy 8	Copy 1
[Print layout]	Select complex or simple print layout	Comp Simp	Comp
[Line break]	Select the number of line breaks between weight values on label.	1 Lfcr 2 Lfcr 3 Lfcr 4 Lfcr 5 Lfcr 6 Lfcr 7 Lfcr 8 Lfcr 9 Lfcr 10 Lfcr	1 Lfcr

Scale will perform the following, depending on the Accumulation and Print Settings:

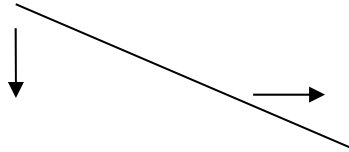
	AC on	AC Off
AUto	Accumulate and print automatically	Print automatically, Do not accumulate
mAn	Accumulate and Print only when [Print/M+/Esc] key pressed. If [Print/M+/Esc] is pressed a second time only print the weight.	Print when [Print/M+/Esc] key is pressed, Do not accumulate.

7.2.2 PC settings

Parameter	Description	Options	Default Values or setting
[baud rate]	Baud Rate	1200 2400 4800 9600 19200 38400 57600 115200	9600
[Model]	Select the scale/model being used.	Adam CBK NBL	Adam
[Interval]	Select the interval per second for sending data to a PC.	Int 0 (continuous) Int 0.5 Int 1 Int 2	Int 0

7.2.3 Command settings

Parameter	Description	Options	Default Values or setting
[baud rate]	Baud Rate	1200 2400 4800 9600 19200 38400 57600 115200	9600

8.0 BATTERY OPERATION

- The scales can be operated from the battery if desired. The battery life can be up to 90 hours depending on the load cells used and how the backlight is used.
- When the battery needs charging a symbol on the display will show less bars in the battery symbol. The battery should be charged when only the battery outline is on. Once the bars have been turned off the scale will still operate for a short time after which it will automatically switch off to protect the battery.
- To charge the battery, simply plug the adaptor into the mains power. The scale does not need to be turned on.
- The battery should be charged for 12 hours for full capacity.
- Near the display is an LED to indicate the status of battery charging. When the scale is plugged into the mains power the internal battery will be charged. If the LED is green the battery has a full charge. If it is Red the battery is nearly discharged and yellow indicates the battery is being charged.

9.0 RS-232 INTERFACE

The AE 403 indicator is supplied with bi-directional RS-232 interface as standard. The scale when connected to a printer or computer outputs the weight with the selected weighing unit through the RS-232 interface.

Specifications:

RS-232 output of weighing data

ASCII code

9600 Baud (user selectable)

8 data bits

No Parity

RS-232 serial interface is a plug as figure 6 shows:

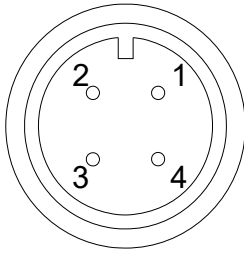

- 1: Pin GND, Signal Ground
- 2: Pin RXD, Received Data
- 3: Pin TXD, Transmitted Data

As viewed from the back of the indicator

The scale can be set to print text in English, French, German, Spanish, Italian or Portuguese. See the RS-232 parameters section for details.

DATA FORMAT - COMPLETE WEIGHT

```
<cr><lf>
<cr><lf>
Date          12/09/2006 <cr><lf>
Time          14:56:27  <cr><lf>
<cr><lf>
Scale ID      123456 <cr><lf>           If ID is zero, it is left blank
User ID      234567 <cr><lf>
<cr><lf>
Net Wt       1.234 Kg <cr><lf>         Net Wt. (or Gross Wt.)
Tare Wt.     0.000kg
Gross Wt.    1.234 Kg
<cr><lf>
<cr><lf>
<cr><lf>
<cr><lf>
```

Data Format-Parts Counting Output:
Weight, Unit weight and number of parts are printed.

```
<cr><lf>
<cr><lf>
Date          12/09/2006 <cr><lf>
Time          14:56:27  <cr><lf>
<cr><lf>
Scale ID      123456  <cr><lf>
User ID       234567  <cr><lf>
<cr><lf>
Net Wt.       1.234 Kg  <cr><lf>      Net Wt. (or Gross Wt.)
Unit Wt.      123 g    <cr><lf>      g for metric and lb for pounds
Pieces        10 pcs  <cr><lf>
<cr><lf>
<cr><lf>
<cr><lf>
<cr><lf>
```

DATA FORMAT – HOLD

```
<cr><lf>
<cr><lf>
Date          12/09/2006 <cr><lf>
Time          14:56:27  <cr><lf>
<cr><lf>
Scale ID      123456  <cr><lf>
User ID       234567  <cr><lf>
<cr><lf>
Hold Wt.      1.000 Kg  <cr><lf>
<cr><lf>
<cr><lf>
<cr><lf>
<cr><lf>
```

DATA FORMAT – PEAK HOLD

```
<cr><lf>
<cr><lf>
Date          12/09/2006 <cr><lf>
Time          14:56:27  <cr><lf>
<cr><lf>
Scale ID      123456  <cr><lf>
User ID       234567  <cr><lf>
<cr><lf>
Peak Holt Wt. 1.500 Kg  <cr><lf>
<cr><lf>
<cr><lf>
<cr><lf>
<cr><lf>
```

DATA FORMAT – ANIMAL

```
<cr><lf>
<cr><lf>
Date          12/09/2006 <cr><lf>
Time          14:56:27  <cr><lf>
<cr><lf>
Scale ID      123456  <cr><lf>
User ID      234567  <cr><lf>
<cr><lf>
Animal Wt.   1.500 Kg  <cr><lf>
<cr><lf>
<cr><lf>
<cr><lf>
<cr><lf>
```

DATA FORMAT – PERCENT

```
<cr><lf>
<cr><lf>
Date          12/09/2006 <cr><lf>
Time          14:56:27  <cr><lf>
<cr><lf>
Scale ID      123456  <cr><lf>
User ID      234567  <cr><lf>
<cr><lf>
Net Wt.       1.500 Kg  <cr><lf>
Ref Wt.       1000kg
Percent       150.00%
<cr><lf>
<cr><lf>
<cr><lf>
<cr><lf>
```

DATA FORMAT – SIMPLE

```
<cr><lf>
<cr><lf>
Net Wt.       1.500 Kg  <cr><lf>
<cr><lf>
Hold Wt.     1000kg
Peak holt wt. 1000kg
Animal wt.   1000kg
Ref. wt.     1000kg
Percent      150.00%
<cr><lf>
Unit wt.     1.0234g
Pieces       1000     PCS
<cr><lf>
<cr><lf>
<cr><lf>
```

DATA FORMAT- CONTINUOUS OUTPUT- NORMAL WEIGHING:

ST,GROSS	1.234 Kg <cr><lf>	ST or US for STable or UnStable,
US,NET	0.000 Kg <cr><lf>	NET or GROSS for Net Weight or Gross wt. and the weighing unit, kg, lb etc.

DATA FORMAT- CONTINUOUS OUTPUT- PARTS COUNTING:

ST Net	1.234 Kg <cr><lf>	Net Weight (or Gross wt.)
U.W.	123 g <cr><lf>	Kg and g for metric and Lb for pounds
PCS	10 pcs <cr><lf>	
	<cr><lf>	
	<cr><lf>	

NOTE:

1. The accumulated total will not be sent to the RS-232 when the continuous print is turned on.
2. The continuous print will only be for the current weight and the display data.
3. In other languages the format is the same but the text will be in the language selected.

Description	ENGLISH	FRENCH	GERMAN	SPANISH	ITALIAN	PORTUGUESE
Date (dd/mm/yyyy)	Date	Date	Datum	Fecha	Data	Data
Time (hh:mm:ss)	Time	Heure	Zeit	Hora	Ora	Hora
Scale Identification Number	Scale ID	Bal ID	Waagen ID	Bal ID	ID Bilancia	ID Bal.
User Identification Number	User ID	Util ID	Nutzer ID	Usuario ID	ID Utiliz.	ID Utiliz.
Net Weight	Net Wt.	Pds Net	Netto-Gew	Pso Neto	Pso Netto	Pso Líq.
Tare Weight	Tare Wt.	Pds Tare	Tara-Gew	Pso Tara	Pso Tara	Pso Tara
Gross Weight	Gross Wt.	Pds Brut	Brut-Gew	Pso Bruto	Pso Lordo	Pso Bruto
Total Weight	Total Wt.	Pds Total	Ges-Gew	Pso Total	Pso Totale	Pso Total
Unit Weight	Unit Wt.	Pds Unité	Gew/Einh	Pso/Unid	Pso/Unità	Pso/Unid
Pieces	Pieces	Pièces	Stck	Piezas	Pezzi	Peças
High Limit, set by user	High Limit	Lim. Supérieure	Obergrenze	Lim. Superior	Lim. Superiore	Lim. Superior
Low Limit, set by user	Low Limit	Lim. Inférieure	Untergrenze	Lim. Inferior	Lim. Inferiore	Lim. Inferior
Number of parts are below the limits	BELOW THE LIMIT	INFÉRIEUR À LA LIMITE	UNTER DER GRENZE	DEBAJO DEL LÍMITE	SOTTO IL LIMITE	ABAIXO DO LIMITE
Number of parts are above the limits	ABOVE THE LIMIT	SUPÉRIEUR À LA LIMITE	ÜBER DER GRENZE	ENCIMA DEL LÍMITE	SOPRA IL LIMITE	ACIMA DO LIMITE
Number of parts are within the limits	ACCEPT	ACCEPTER	AKZEPTIEREN	ACEPTAR	ACCETTO	ACEITAR
Reference weight	Ref. Wt.	Pds Ref	Ref-Gew	Pso Ref	Pso Rif	Pso Ref
Percentage	Percent	Pourcentage	Prozentsatz	Porcentaje	Percentuale	Percentagem
Animal Weight	Animal Wt.	Pds Animal	Tier-Gew	Pso Animal	Pso Animale	Pso Animal
Hold Weight	Hold Wt.	Pds Tenu	Halt-Gew	Pso Retenido	Pso Contenido	Pso Guardado
Peak Hold Weight	Peak Hold Wt.	Pds de Crete	Höchstwert-Gew	Pso Mas Alto	Pso di Punta	Pso Mais Alto

9.1 INPUT COMMANDS FORMAT

The scale can be controlled with the following commands. Press the **[Enter]** key on the PC after each command.

T<cr><lf>	Tares the scale to display the net weight. This is the same as pressing [Tare/←] .
Z<cr><lf>	Sets the zero point for all subsequent weighing. The display shows zero.
P<cr><lf>	Prints the results to a PC or printer using the RS-232 interface. It also adds the value to the accumulation memory if the accumulation function is not set to automatic.

10.0 RELAY INTERFACE (FACTORY FIT OPTION)

The AE 403 indicator can be fitted with drivers to control external relays. This is a factory fit option; the drivers could be used to control a number of different relays depending upon the users need. The relay drivers are isolated outputs requiring the use of an external power supply for the relays.

Contact Adam Equipment or your supplier for a relay interface that is compatible with the relay drivers, however other interfaces can be used as long as the following conditions apply.

Connections to the drivers:

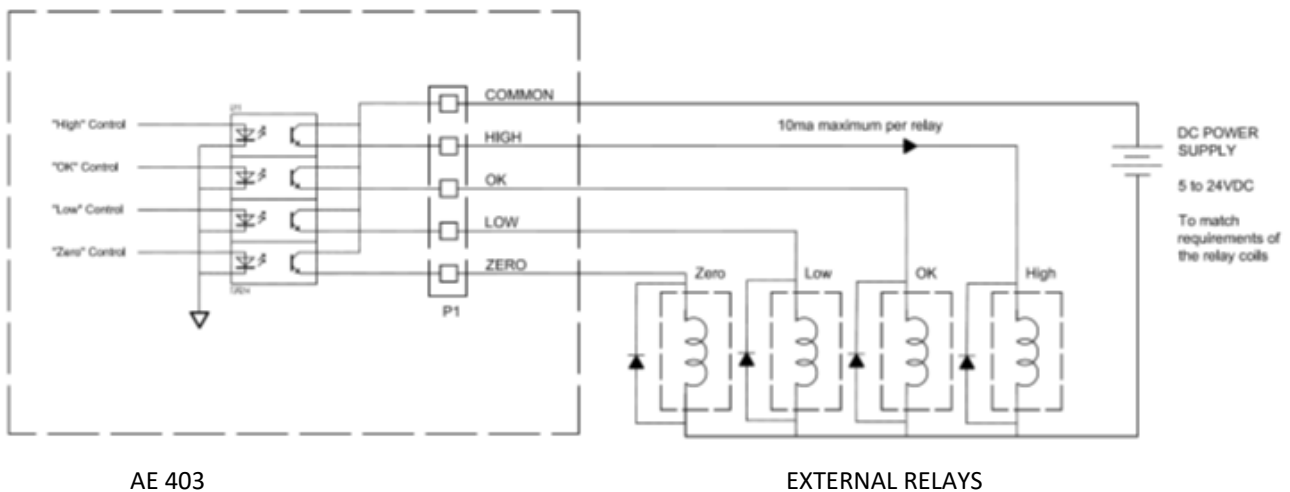

Connections are made to the PCB, Connector P1. The connector is a spring activated type, simply press on the top of the connector and insert the wire.

Do not exceed the safe limits of voltage or current of 24VDC or 15ma per output.

Depending upon the application it may be necessary to use a small relay to drive larger relays, or to provide additional protection to prevent electromagnetic interference (diodes as shown above) to this or other machinery.

11.0 CALIBRATION

The AE 403 indicator can be calibrated using either metric or pound weights, depending on the weighing unit in use before calibration. The display will show either "kg" or "lb" to identify the weights expected.

The indicator can be calibrated using the following procedure:

- Turn on the power and wait for the scale to configure.
- Before configuration is completed, hold down the **[Tare]** ↵ key to bring up the user password information screen.
- To enter the password, use the directional buttons ↑ or ↓ to scroll through numbers 1-9. Use the → directional key to move to the next digit.
- Entering the correct password **[1000]** and pressing **[Tare]** for confirmation will bring you to the user setup menu;
- Within the menu, use the directional buttons ↑ or ↓ to scroll through the settings until **'U-cal'** appears on the display. Press the **[Tare]** ↵ key to select.
- After pressing **[Tare]** ↵, depending on the version of the indicator, it may allow the calibration to be performed using **kg** or **Lb**, if this is the case, use the directional buttons ↑ or ↓ to scroll through **kg** or **Lb**, Press the **[Tare]** ↵ key to select.
- At this point **'noload'** should appear on the display. Ensure the weighing platform is empty and the stability symbol **'~'** is showing, and then press **[Tare]** ↵ key to accept.
- The display shows **'load1'**, then jumps to **'1.000'**, with the last digit flashing. Press **[CE]** key can clear original readings. Use ↑ or ↓ key to change the parameter, use → directional key to move to the next digit. Usually, load 1 is set to indicator's full capacity. Select the value of the calibration weight to be used, and press **[Tare]** ↵ to accept.
- When the display shows **'Load'**, put specified weight on the weighing platform. When stable symbol **'~'** appears again, press **[Tare]** ↵ to accept.
- If the calibration is successfully completed, the indicator will restart.

12.0 ERROR CODES

ERROR CODES	DESCRIPTION	SUGGESTIONS
--oL--	Weight Overload	Weight exceed maximum capacity. Remove weight from the scale. If the problem persists, contact your dealer or Adam Equipment for assistance.
--L0--	Below Gross zero by >20e	Weight below scale range. Check if the pan has been removed. If the problem persists, contact your dealer or Adam Equipment for assistance.
Err 1	Time Setting Error	Enter time using correct format and reasonable values. Format: hh:mm:ss.
Err 2	Date Setting Error	Enter date using correct format and reasonable values. Format: yy:mm:dd.
Err 3	Unstable Power On Zero Error	The readings at the start-up were unstable, and the scale couldn't set the zero reference. Check if the scale is leveled and placed on a stable surface.
Err 4	Zero Setting Error	The scale was outside the normal zero setting range either when it was turned on or when the [Zero] key was pressed. Remove weight from the scale and try re-zeroing again. Use the [Z/T] key to set the display to zero value. If the problem persists, contact your dealer or Adam Equipment for assistance.
Err 5	Key Zeroing error	Trying to zero a value that is larger than the maximum allowed, remove some of the mass before using the [Zero] key.
Err 6	Negative tare error	Pressing tare with a negative value.
Err 7	Stability error	Draft or vibrations causes unstable weight readings. Check if the scale is leveled and placed on a stable surface.
Err 8	Percent input error	Percent function is entered with no reference mass on the pan.
Err 9	User zero calibration exceed factory calibration >10%	Improper calibration (should be within $\pm 10\%$ of the factory calibration). The old calibration data will be retained until the calibration process is complete.
Err 10	User load calibration exceed factory calibration >10%	Improper calibration (should be within $\pm 10\%$ of the factory calibration). The old calibration data will be retained until the calibration process is complete.
Err 17	Out of specification for approved model	Number of divisions set to higher than 1/6000.
Err 18	Memory Error	Values read from memory are different from the expected.
Err 19	Weight lower limit is larger than upper limit	High limit is set first, then the low limit is set higher than the high limit and low limit not equal to zero.
Err ADC	Incorrect ADC value	Load cell or electronics could be damaged. Try restart the scale, If the problem persists contact your dealer or Adam Equipment for assistance.

13.0 REPLACEMENT PARTS AND ACCESSORIES

If you need to order any spare parts and accessories, contact your supplier or Adam Equipment. A partial list of such items is as follows-

- | | |
|---|---|
| <ul style="list-style-type: none">• Power Supply Module• Replacement Battery | <ul style="list-style-type: none">• Printer, etc. |
|---|---|

14.0 SERVICE INFORMATION

This manual covers the details of operation. If you have a problem with the scale that is not directly addressed by this manual then contact your supplier for assistance. In order to provide further assistance, the supplier will need the following information which should be kept ready:

A. Details of your company

Name of your company:

Contact person's name:

Contact telephone, e-mail, fax or any other methods:

B. Details of the unit purchased

(This part of information should always be available for any future correspondence. We suggest you to fill in this form as soon as the unit is received and keep a print-out in your record for ready reference.)

Model name of the scale:	
Serial number of the unit:	
Software revision number (Displayed when power is first turned on):	
Date of Purchase:	
Name of the supplier and place:	

C. Brief description of the problem

Include any recent history of the unit. For example:

- Has it been working since it's delivered
- Has it been in contact with water
- Damaged from a fire
- Electrical Storms in the area
- Dropped on the floor, etc.

WARRANTY STATEMENT

Adam Equipment offers Limited Warranty (Parts and Labour) for any components that fail due to defects in materials or workmanship. Warranty starts from the date of delivery.

During the warranty period, should any repairs be necessary, the purchaser must inform its supplier or Adam Equipment Company. The company or its authorised Technician reserves the right to repair or replace the components at any of its workshops at no additional cost, depending on the severity of the problems. However, any freight involved in sending the faulty units or parts to the Service Centre should be borne by the purchaser.

The warranty will cease to operate if the equipment is not returned in the original packaging and with correct documentation for a claim to be processed. All claims are at the sole discretion of Adam Equipment.

This warranty does not cover equipment where defects or poor performance is due to misuse, accidental damage, exposure to radioactive or corrosive materials, negligence, faulty installation, unauthorised modifications or attempted repair, or failure to observe the requirements and recommendations as given in this User Manual.

This product may include a rechargeable battery that is designed to be removed and replaced by the user. Adam Equipment warrants that it will provide a replacement battery if the battery manifests a defect in materials or workmanship during the initial period of use of the product in which the battery is installed.

As with all batteries, the maximum capacity of any battery included in the product will decrease with time or use, and battery cycle life will vary depending on product model, configuration, features, use, and power management settings. A decrease in maximum battery capacity or battery cycle life is not a defect in materials or workmanship, and is not covered by this Limited Warranty.

Repairs carried out under the warranty do not extend the warranty period. Components removed during warranty repairs become company property.

The statutory rights of the purchaser are not affected by this warranty. The terms of this warranty is governed by the UK law. For complete details on Warranty Information, see the terms and conditions of sale available on our web-site.

WEEE 2012/19/EU

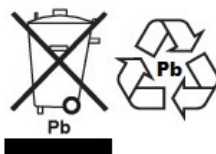

This device may not be disposed of in domestic waste. This also applies to countries outside the EU, per their specific requirements. Disposal of batteries (if fitted) must conform to local laws and restrictions.

Cet appareil ne peut être éliminé avec les déchets ménagers. L'élimination de la batterie doit être effectuée conformément aux lois et restrictions locales.

Dieses Gerät nicht mit dem Hausmüll entsorgt.

Dispositivo no puede ser desechado junto con los residuos domésticos

Dispositivo non può essere smaltito nei rifiuti domestici.

FCC / IC CLASS A DIGITAL DEVICE EMC VERIFICATION STATEMENT

NOTE: This equipment has been tested and found to comply with the limits for a Class A digital device, pursuant to Part 15 of the FCC rules and Canadian ICES-003/NMB-003 regulation. These limits are designed to provide reasonable protection against harmful interference when the equipment is operated in a commercial environment. This equipment generates, uses and can radiate radio frequency energy and, if not installed and used in accordance with the instruction manual, may cause harmful interference to radio communications. Operation of this equipment in a residential area is likely to cause harmful interference in which case the user will be required to correct the interference at his own expense.

CALIFORNIA PROPOSITION 65 - MANDATORY STATEMENT

WARNING: This product includes a sealed lead-acid battery which contains chemicals known to the State of California to cause cancer and birth defects or other reproductive harm.



Adam Equipment products have been tested with, and are always supplied with mains power adaptors which meet all legal requirements for the intended country or region of operation, including electrical safety, interference and energy efficiency. As we often update adaptor products to meet changing legislation it is not possible to refer to the exact model in this manual. Please contact us if you need specifications or safety information for your particular item. Do not attempt to connect or use an adaptor not supplied by us.

ADAM EQUIPMENT is an ISO 9001:2015 certified global company with more than 40 years' experience in the production and sale of electronic weighing equipment.

Adam products are predominantly designed for the Laboratory, Educational, Health and Fitness, Retail and Industrial Segments. The product range can be described as follows:

- Analytical and Precision Laboratory Balances
- Compact and Portable Balances
- High Capacity Balances
- Moisture analysers / balances
- Mechanical Scales
- Counting Scales
- Digital Weighing/Check-weighing Scales
- High performance Platform Scales
- Crane scales
- Mechanical and Digital Electronic Health and Fitness Scales
- Retail Scales for Price computing

For a complete listing of all Adam products visit our website at

www.adamequipment.com

<p>Adam Equipment Co. Ltd. Maidstone Road, Kingston Milton Keynes MK10 0BD UK Phone:+44 (0)1908 274545 Fax: +44 (0)1908 641339 e-mail: sales@adamequipment.co.uk</p>	<p>Adam Equipment Inc. 1, Fox Hollow Rd. Oxford, CT 06478 USA Phone: +1 203 790 4774 Fax: +1 203 792 3406 e-mail: sales@adamequipment.com</p>	<p>AE Adam GmbH. Instenkamp 4 D-24242 Felde Germany Phone +49 (0)4340 40300 0 Fax: +49 (0)4340 40300 20 e-mail: vertrieb@aeadam.de</p>
<p>Adam Equipment S.A. (Pty) Ltd. 7 Megawatt Road, Spartan EXT 22 Kempton Park, Johannesburg, Republic of South Africa Phone +27 (0)11 974 9745 Fax: +27 (0)11 392 2587 e-mail: sales@adamequipment.co.za</p>	<p>Adam Equipment (S.E. ASIA) PTY Ltd 70 Miguel Road Bibra Lake Perth WA 6163 Australia Phone: +61 (0) 8 6461 6236 Fax +61 (0) 8 9456 4462 e-mail: sales@adamequipment.com.au</p>	<p>Adam Equipment (Wuhan) Co. Ltd. A Building East Jianhua Private Industrial Park Zhuanyang Avenue Wuhan Economic & Technological Development Zone 430056 Wuhan P.R.China Phone: + 86 (27) 59420391 Fax + 86 (27) 59420388 e-mail: info@adamequipment.com.cn</p>

© Copyright by Adam Equipment Co. All rights reserved. No part of this publication may be reprinted or translated in any form or by any means without the prior permission of Adam Equipment.

Adam Equipment reserves the right to make changes to the technology, features, specifications and design of the equipment without notice.

All information contained within this publication is to the best of our knowledge timely, complete and accurate when issued. However, we are not responsible for misinterpretations which may result from the reading of this material.

The latest version of this publication can be found on our Website.

www.adamequipment.com